

User manual

OLCT 20

Gas Detector



*Part Number: NPO20GB
Revision: E.0*

OLDHAM
The Fixed Gas Detection Experts

Copyright April 2018 by *Oldham S.A.S*

All rights reserved. No reproduction of all or part of this document, in any form, is permitted without the written consent of Oldham S.A.S.

All information provided in this document is accurate to the best of our knowledge.

As a result of continuous research and development, the specifications of this product may be changed without prior notice.

Oldham S.A.S
Rue Orfila
Z.I. Est – CS 20417
F – 62027 ARRAS Cedex
Tel: +33 (0)3 21 60 80 80
Fax: +33 (0)3 21 60 80 00

Table of Contents

Chapter 1	 Overview	1
Limitation of Liability	1
Ownership clauses	1
Warnings	1
Warranty	2
Important Information	2
Destruction of equipment	2
Symbols used	3
Chapter 2	 Description	5
Overview	5
Main characteristics of the various versions	5
Mechanical installation of the various versions	6
Chapter 3	 Wiring Arrangements	7
3-wire version (OLC 20d, OLCT 20d)	7
2-wire version (OLCT 20d)	7
2-wire Intrinsic Safety version (OLCT 20i)	8
Chapter 4	 Installation	9
Regulations and operating conditions	9
Equipment required	9
Positioning the detector	9
Mounting the detector	10
Chapter 5	 Maintenance	11
Maintenance frequency	11
Detector OLC 20	12
Transmitters OLCT 20	12
Replacing a sensor on OLCT 20	14
Chapter 6	 Spare Parts	15
Flameproof approved replacement sensors	15
Intrinsically-safe approved replacement sensors	16
Chapter 7	 Accessories	17
Chapter 8	 Technical Specifications	19
Common	19
OLC 20d	19
OLCT 20d	19
OLCT 20i	19
Sensors	20
Cross gas factors for combustible gases	21

Chapter 9	 EU Declaration of Conformity.....	25
------------------	--	-----------

Chapter 10	 Special instructions for use in explosive atmospheres and functional safety.....	27
-------------------	---	-----------

General comments	27
Warnings.....	27
Requirements for use in dust explosive atmospheres.....	27
Cable entries.....	27
Threaded joints	28
Limitations of use.....	28
Transfer curve for OLCT20 gas detectors	29
Marking	29

Chapter 1 | Overview

Thank you for choosing this OLDHAM instrument.

All necessary actions have been taken to ensure your complete satisfaction with this equipment.

It is important that you read this entire manual carefully and thoroughly.

Limitation of Liability

- OLDHAM shall not be held responsible for any damage to the equipment or for any physical injury or death resulting in whole or in part from the inappropriate use or installation of the equipment, non-compliance with any and all instructions, warnings, standards and/or regulations in force.
- No business, person or legal entity may assume responsibility on behalf of OLDHAM, even though they may be involved in the sale of OLDHAM products.
- OLDHAM shall not be responsible for any direct or indirect damage, or any direct or indirect consequence, resulting from the sale and use of any of its products **UNLESS SUCH PRODUCTS HAVE BEEN SELECTED BY OLDHAM ACCORDING TO THE APPLICATION.**

Ownership clauses

- The drawings, specifications, and information herein contain confidential information that is the property of OLDHAM.
- This information shall not, either in whole or in part, by physical, electronic, or any other means whatsoever, be reproduced, copied, divulged, translated, or used as the basis for the manufacture or sale of OLDHAM equipment, or for any other reason **without the prior written consent of OLDHAM.**

Warnings

- This is not a contractual document. **OLDHAM** reserves the right to alter the technical features of its equipment at any time and for any reason without prior notice.
- **READ THESE INSTRUCTIONS CAREFULLY BEFORE USING FOR THE FIRST TIME:** these instructions should be read by all persons who have or will have responsibility for the use, maintenance, or repair of the instrument.
- This instrument shall only be deemed to be in conformance with the published performance if used, maintained, and repaired in accordance with the instructions of OLDHAM, by OLDHAM personnel, or by personnel authorized by OLDHAM.

Warranty

Under normal conditions of use and on return to the factory, parts and workmanship are guaranteed for 2 years, excluding consumables such as sensors, filters, etc.

Important Information

The modification of the material and the use of parts of an unspecified origin shall entail the cancellation of any form of warranty.

The use of the unit has been projected for the applications specified in the technical characteristics. Exceeding the indicated values cannot in any case be authorized.

Catalytic sensors are susceptible to poisoning by traces of several substances. This leads to an inhibition which can be permanent or temporary depending on the contaminant, the concentration of the contaminant, the duration of exposure to the contaminant.

Poisoning may result from exposure to substances as:

- silicones (e.g. waterproofing, adhesives, release agents, special oils and greases, certain medical products, commercial cleaning agents)
- tetraethyl lead (e.g. leaded petrol, particularly aviation petrol 'Avgas')
- sulfur compounds (sulfur dioxide, hydrogen sulfide)
- halogenated compounds (R134a, HFO, etc.)
- organo-phosphorus compounds (e.g. herbicides, insecticides, and phosphate esters in fireproof hydraulic fluids)

Oldham recommends regular testing of fixed gas detection installations (read 0).

Destruction of equipment







European Union only. This symbol indicates that, in conformity with directive DEEE (2002/96/CE) and in accordance with local regulations, this product must not be discarded with household waste.

It must be disposed of in a collection area that is designated for this purpose, for example at a site that is officially designated for recycling of electrical and electronic equipment (EEE) or a point of exchange for authorized products in the event of the acquisition of a new product of the same type.



The OLCT80 transmitter contains a lithium ion battery intended to supply power to certain parts of the electronic circuit. The battery will be removed prior to the destruction of the transmitter and deposited in a collection center for used batteries.

Symbols used

Icon	Signification
	This symbol indicates: useful additional information.
	This symbol indicates: This equipment must be connected to ground.
	This symbol denotes: Protective earth terminal. A cable of the adequate diameter must be connected to ground and to the terminal having this symbol
	This symbol denotes: Attention! In the present mode of use, failure to adhere to the instructions preceded by this symbol can result in a risk of electric shock and/or death.
	This symbol indicates: You must refer to the instructions.

Chapter 2 | Description

Overview

OLC 20 gas detectors are catalytic type detectors intended for the detection of combustible gases. They are flameproof certified (OLC 20d).

OLCT 20 gas detectors are 4-20 mA transmitters and are intended for the measurement of combustible and toxic gases and oxygen. They are either flameproof certified (OLCT 20d) or intrinsically safe certified (OLCT 20i).

OLC 20s and OLCT 20s are available in 3/4 NPT or M25 screw fittings and are designed to be attached on a junction box or any compatible generic transmitters.

Main characteristics of the various versions

	OLC 20	OLCT 20	
	LEL	LEL	TOX/O ₂
Flameproof design	✓	✓	✓
Intrinsic safety design			✓
3-wire cable / Wheatstone bridge	✓		
3-wire cable / 4-20 mA output		✓	
2-wire cable / 4-20 mA output			✓
Catalytic sensor	✓	✓	
Electrochemical sensor			✓
Replacement catalytic sensor	✓		
Replacement pre-calibrated sensor		✓	✓

Mechanical installation of the various versions

Please ensure you read the paragraph: Special Specifications for use in Potentially Explosive Atmospheres in Accordance with European Directive ATEX 2014/34/EU.

See **Appendix 1** for general installation instructions.

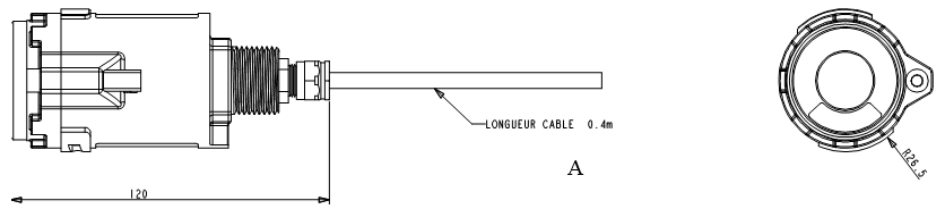

Figure 1 : Dimensions

	A
Dimensions OLC/OLCT 20	Cable length 0.2 m

Chapter 3 | Wiring Arrangements

Please ensure you read the paragraph: Special Specifications for use in Explosive Atmospheres in Accordance with European Directive ATEX 2014/34/EU.

3-wire version (OLC 20d, OLCT 20d)

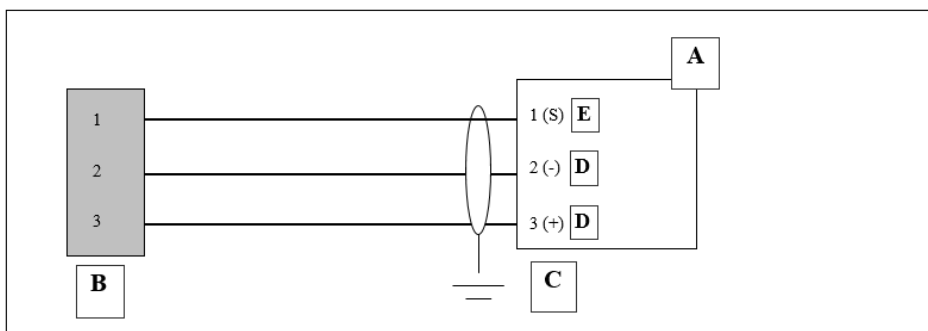

Figure 2

A	B	C	D	E
OLDHAM controller	OLC or OLCT 20	Grounding	Power supply	Signal (I)

2-wire version (OLCT 20d)

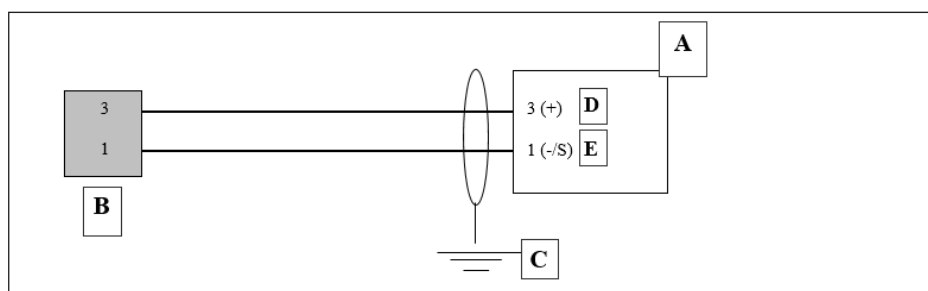

Figure 3

A	B	C	D	E
OLDHAM controller	OLCT 20	Grounding	Power supply	Signal (I)

2-wire Intrinsic Safety version (OLCT 20i)

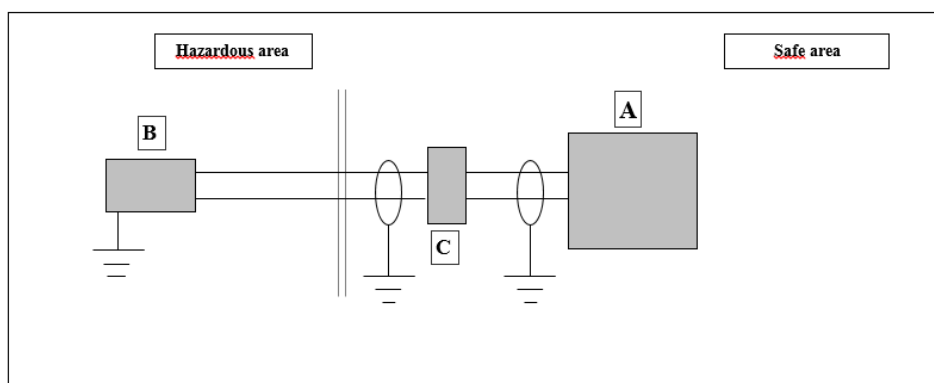

Figure 4

A	B	C
OLDHAM controller	OLCT 20	Zener Barrier

Chapter 4 | Installation



It is recommended that you read the relevant guides for installing, operating and maintaining flammable gas and oxygen detectors (EN 60079-29-2) and toxic detectors (EN 45544-4).

Regulations and operating conditions

- Installation must comply with current edition of EN 60079-14 for systems installed in explosive atmospheres and eventually with any local or national additional requirements that may apply in the country of installation.
- In general, the ambient temperature, the power supply voltage and power mentioned in this document pertain to safety precautions against explosion. These temperatures are not the detector's operating temperatures.
- OLC20d and OLCT20d are authorized for use in zones 1, 2, 21 and 22 for ambient temperatures ranging between -20°C to +70°C (except OLC20d HT. See Chapter 10).
- OLCT20i are authorized for use in zones 0, 1, 2, 20, 21 and 22 for ambient temperatures ranging between -20°C to +70°C.
- The detection sensor must always be in contact with the ambient air. Therefore:
 - Do not cover the detection module.
 - Do not apply paint on the detection module.
 - Keep dust from building up.

Equipment required

- Complete detector.
- Connection cable.
- Tools for mounting the device.
- Mounting materials.

Positioning the detector

The detector should be positioned at ground level, on the ceiling, at the height of the respiratory tract or near air extraction ducts, depending on the application or the density of the gas to be detected. Heavy gases should be detected at ground level, while light gases should be detected at ceiling height.

Mounting the detector

The detector must be installed with the detection sensor pointing downwards. For combustible gas detectors, tilting the device more than 45° past vertical can lead to imprecise readings.

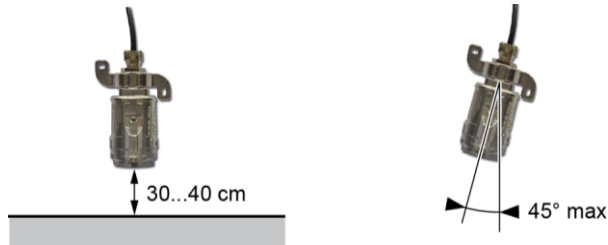

Despite its high degree of protection (IP66), it may be necessary to protect the detector against adverse weather conditions (rain, dust, direct sunlight, etc.) and from direct spraying with cleaning or maintenance products (causing soiling of the detection sensor).

The detector must also be positioned so as to allow access to the measuring sensor so that it can be replaced easily.

Factors to be considered in determining optimal detector positioning:

- ⇒ potential sources of gas and vapour emissions
- ⇒ chemical and physical data on gases and vapours which may be present
- ⇒ liquids with low volatility (place the detectors as near as possible to the leak)
- ⇒ type and concentration of gas leaks (high-pressure jet, slow leak, etc.)
- ⇒ air movements:
 - indoors: natural and mechanical ventilation
 - outdoors: wind speed and direction
- ⇒ effect of temperature
- ⇒ installation so as to avoid mechanical damage or deterioration caused by water in summer
- ⇒ positioning to allow easy maintenance, if possible
- ⇒ avoiding direct sunlight on the readout area as this would lead to maintenance problems

Chapter 5 | Maintenance



The operations explained in this section must be performed by authorized, qualified personnel because they could affect detection reliability. Inspection and maintenance must be carried out in accordance with the current editions of EN60079-17 and eventually with any local or national additional requirements that may apply in the country of installation.

It is prohibited to open the transmitter when energized

Periodic inspections ensure that the equipment and system is functioning properly and providing reliable detection services. The section describes the preventative maintenance procedures required and how often they are to be performed. Inspection and maintenance must be carried out in accordance with the current editions of EN60079-17 and eventually with any local or national additional requirements that may apply in the country of installation.

Maintenance frequency

Gas detectors are safety devices. Oldham recommends regular testing of fixed gas detection installations. This type of test involves injecting a standard gas of sufficient concentration into the detector to trigger pre-set alarms. This test does not, in any event, replace a full calibration of the detector.

Frequency of gas testing depends on the industrial application in which the detector is used. Inspection should occur frequently during the months following installation start-up; later it may be spaced out if no significant problem is observed. If a detector does not react upon contact with gas, it must be calibrated. Calibration frequency will depend on the results of these tests (moisture, temperature, dust, etc.); however, the device should be calibrated at least once per year.

The site manager is responsible for implementing the safety procedures at the site. Oldham is not responsible for implementing safety procedures.

Detector OLC 20

Calibration

On the controller	On the detector
<p>Set the measuring channel to the calibration position (alarm relays inhibited)</p> <p>Proceed the zero and span</p> <p>Set the measuring channel back to the "normal" position and make sure that it is working properly.</p>	 <p>Apply the calibration cup and perform the calibration in accordance with the procedure defined during the training course provided by OLDHAM or by an OLDHAM's authorized person</p>

Replacing a sensor on an OLC 20

When?

- When the sensor is damaged or cannot be calibrated
- On a preventive basis

How?

- Turn off the relevant measuring channel
- Remove the sensor to be replaced
- Replace it with a new sensor
- Turn on the channel and check that it operates correctly

Transmitters OLCT 20



OLCT 20 gas transmitters are equipped with a pre-calibrated sensor and do not require any adjustment on installation.

However, as gas detectors are safety equipment, it is recommended to bump test the complete transmitter after a sensor replacement.

Calibration

After removing the sensor from the transmitter, perform the calibration by using the calibrating bench provided for that purpose (see CALIBRO's user manual).

Procedure

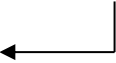
On the controller	On the detector
<p>Set the measuring channel to the calibration position (alarm relays inhibited)</p>	<div style="text-align: right;"> <p>Loosen the locking screw</p>  </div> <div style="text-align: right;"> <p>1 Rotate the sensor module and extract it</p>  <p>2</p> </div> <div style="text-align: center;">  </div> <p>Once calibrated put the sensor back in place or use a replacement sensor and reinstall the whole assembly.</p>
<p>Set the measuring channel back to the "normal" position and make sure that it is working properly.</p>	

Calibration specifications



Calibration shall be performed **outside classified areas** and by using **suitable equipment** that is described during the training course provided by OLDHAM or by a person authorized by OLDHAM.

OLCT 20 sensor module (LEL/TOX/O₂)

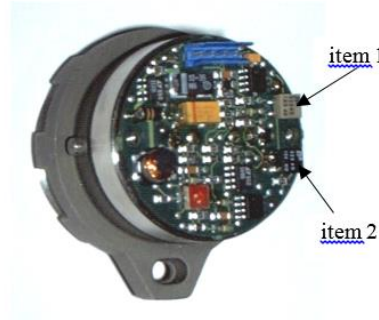

- Adjustment of 0 in clean air, using potentiometer (item 1).
- Adjustment of sensitivity (with standard gas), using the potentiometer (item 2).

Replacing a sensor on OLCT 20

When?

- When the sensor is damaged or cannot be calibrated.
- On a preventive basis.

How?

- Turn off the relevant measuring channel.
- Remove the sensor to be replaced.
- Replace it with a new, precalibrated unit.
- Turn the channel on and check that it operates correctly.



All replacement parts must be Oldham-manufactured parts. The use of non-Oldham parts could jeopardize the instrument's safety.

Flameproof approved replacement sensors

Part number	Description
6 313 757	OLC 20d sensor cell, 0-100% LEL, VQ1 type
6 313 758	OLC 20d sensor cell, 0-100% LEL, 4F type
6 313 995	OLC20d sensor cell, 0-100% LEL, butadiene/acetylene, VQ1 type
6 313 759	OLC20d sensor cell, 0-100% vol. CH ₄
6 314 204	OLC 20d sensor cell, 0-100% vol. H ₂
6 313 988	OLC 20d sensor cell, 0-100% vol. SF ₆
6 313 689	OLC 20d HT sensor cell, 0-100% LEL, VQ1 type
6 313 685	OLCT 20d sensor cell, 0-100% LEL, VQ1 type
6 313 974	OLCT 20d poison control sensor cell, 0-100% LEL, 4F type
6 313 872	OLCT 20d sensor cell, 0-100% LEL, butadiene/acetylene, VQ1 type
6 313 687	OLCT 20d sensor cell, 0-100% vol. CH ₄
6 313 986	OLCT 20d sensor cell, 0-100% vol. SF ₆
6 313 203	OLCT 20d sensor cell, 0-100% vol. H ₂
6 314 100	Infrared sensor cell, 0-5% vol. CO ₂ , for OLCT 20 XP IR
6 314 101	Infrared sensor cell, 0-10% vol. CO ₂ , for OLCT 20 XP IR
6 314 146	Infrared sensor cell, 0-100% vol. CO ₂ , for OLCT 20 XP IR
6 313 710	OLCT 20d O ₂ sensor cell, 0-30% vol.
6 313 707	OLCT 20d NH ₃ sensor cell, 0-100 ppm
6 313 708	OLCT 20d NH ₃ sensor cell, 0-1000 ppm
6 313 894	OLCT 20d NH ₃ sensor cell, 0-5000 ppm
6 313 690	OLCT 20d CO sensor cell, 0-100 ppm
6 313 691	OLCT 20d CO sensor cell, 0-300 ppm
6 313 692	OLCT 20d CO sensor cell, 0-1000 ppm
6 313 693	OLCT 20d CO (H ₂ null) sensor cell, 0-1000 ppm
6 313 695	OLCT 20d H ₂ S sensor cell, 0-30 ppm
6 313 965	OLCT 20d H ₂ S sensor cell, 0-30 ppm, no HC interference
6 313 696	OLCT 20d H ₂ S sensor cell, 0-100 ppm
6 313 697	OLCT 20d H ₂ S sensor cell, 0-1000 ppm
6 313 698	OLCT 20d sensor cell, 0-100 ppm NO
6 313 699	OLCT 20d sensor cell, 0-300 ppm NO
6 313 700	OLCT 20d sensor cell, 0-1000 ppm NO
6 313 706	OLCT 20d sensor cell, 0-2000 ppm H ₂
6 313 772	OLCT 20d sensor cell, methylene/methylene chloride

Part number	Description
6 313 773	OLCT 20d sensor cell, R12
6 313 774	OLCT 20d sensor cell, R134a
6 313 775	OLCT 20d sensor cell, MOS

Intrinsically-safe approved replacement sensors

Part number	Description
6 313 748	OLCT 20i O ₂ sensor cell, 0 - 30% vol.
6 313 728	OLCT 20i NH ₃ sensor cell, 0-100 ppm
6 313 729	OLCT 20i NH ₃ sensor cell, 0-1000 ppm
6 313 895	OLCT 20i NH ₃ sensor cell, 0-5000 ppm
6 313 694	OLCT 20i CO (H ₂ null) sensor cell, 0-1000 ppm
6 313 711	OLCT 20i CO sensor cell, 0-100 ppm
6 313 712	OLCT 20i CO sensor cell, 0-300 ppm
6 313 713	OLCT 20i CO sensor cell, 0-1000 ppm
6 313 716	OLCT 20i H ₂ S sensor cell, 0-30 ppm
6 313 717	OLCT 20i H ₂ S sensor cell, 0-100 ppm
6 313 718	OLCT 20i H ₂ S sensor cell, 0-1000 ppm
6 313 719	OLCT 20i NO sensor cell, 0-100 ppm
6 313 720	OLCT 20i NO sensor cell, 0-300 ppm
6 313 721	OLCT 20i NO sensor cell, 0-1000 ppm
6 313 722	OLCT 20i NO ₂ sensor cell, 0-10 ppm
6 313 723	OLCT 20i NO ₂ sensor cell, 0-30 ppm
6 313 727	OLCT 20i H ₂ sensor cell, 0-2000 ppm
6 313 730	OLCT 20i HCl sensor cell, 0-30 ppm
6 313 731	OLCT 20i HCl sensor cell, 0-100 ppm
6 313 724	OLCT 20i SO ₂ sensor cell, 0-10 ppm
6 313 725	OLCT 20i SO ₂ sensor cell, 0-30 ppm
6 313 726	OLCT 20i SO ₂ sensor cell, 0-100 ppm
6 313 734	OLCT 20i Cl ₂ sensor cell, 0-10 ppm
6 313 746	OLCT 20i ETO sensor cell, 0-50 ppm
6 313 732	OLCT 20i HCN sensor cell, 0-10 ppm
6 313 733	OLCT 20i HCN sensor cell, 0-30 ppm
6 313 736	OLCT 20i COCl ₂ sensor cell, 0-1 ppm
6 313 740	OLCT 20i ClO ₂ sensor cell, 0-3 ppm
6 313 735	OLCT 20i O ₃ sensor cell, 0-1 ppm
6 313 737	OLCT 20i PH ₃ sensor cell, 0-1 ppm
6 313 739	OLCT 20i HF sensor cell, 0-10 ppm
6 313 738	OLCT 20i AsH ₃ sensor cell, 0-1 ppm
6 313 747	OLCT 20i SiH ₄ sensor cell, 0-50 ppm

Chapter 7 | Accessories

Accessory	Use	Illustration	Code
Tool kit	Tool kit for maintenance.		6147869
Gas injection pipe	Inject the calibration gas onto the measurement sensor. Impact on reading: measurement similar to measurement in diffusion mode. Impact on response time: none.		6331141 ⚠ Plastic material. Risk of electrostatic charges. Wipe with a damp cloth
Gas flow head	Used to take bypass readings. Impact on reading: none if calibration is performed under the same conditions (pipe, flow rate). Impact on response time: none.		6327910 ⚠ Plastic material. Risk of electrostatic charges. Wipe with a damp cloth
Splash guard	Protects the detector from liquids. Impact on reading: none. Impact on response time: response time in diffusion mode may increase for certain gases; contact us for more information.		6329004 ⚠ Plastic material. Risk of electrostatic charges. Wipe with a damp cloth
Splash guard in Stainless Steel	Protects the detector from liquids. Impact on reading: none. Impact on response time: response time in diffusion mode may increase for certain gases; contact us for more information.		6129010
Splash guard (high risk)	Protects the detector from liquids. Impact on reading: none. Impact on response time: response time may increase for certain gases; contact us for more information.		6329014 ⚠ Plastic material. Risk of electrostatic charges. Wipe with a damp cloth
Remote gas injection head	Used to detect ambient gases while a calibration gas injection pipe is being used. Only for combustible gases, Impact on reading: none. Impact on response time: negligible.		6327911 ⚠ Plastic material. Risk of electrostatic charges. Wipe with a damp cloth
Removable PTFE protection filter	Protects the gas inlet from liquids and dust. Impact on reading: none, but this part cannot be used for the detection of O ₃ , HCL, HF and Cl ₂ . Impact on response time: response time may increase for certain gases; contact us for more information.		6335975 ⚠ Plastic material. Risk of electrostatic charges. Wipe with a damp cloth

Chapter 8 | Technical Specifications

Common

Ingress Protection	IP66
Weight	800 g
Dimensions	60 X 120 mm
Source mode current	4-20 mA
Max. current	25 mA
Fault current	<1 mA

OLC 20d

Power supply:	voltage on detector terminals = 2.8 V max
Power consumption:	3-wire version = 400 mA max
Measurement signal:	Wheatstone bridge
Line length (shielded cable):	3-wire version = 1 km with 3x1.5 mm ² (32 ohms in loop mode)
Output signal	mV bridge output, 3 wires

OLCT 20d

Power supply:	voltage on detector terminals = 15 Vdc to 30 Vdc
Power consumption:	3-wire version = 100 mA 2-wire version = 25 mA
Load resistance:	maximum resistance = 250 ohms
Line length (shielded cable):	3-wire version = 1 km as 3x 1.5 mm ² (32 ohms in loop mode) 2-wire version = 4 km as 3x 1.5 mm ² (32 ohms in loop mode)

OLCT 20i

Zener barrier:	28 Vdc max - 300 ohms
Supply voltage for barrier:	19 Vdc to 26 Vdc
Voltage on detector terminals:	10 Vdc to 26 Vdc
Power consumption:	25 mA max
Load resistance:	47 ohms
Line length (shielded cable):	1 km as 3x 1.5 mm ² (32 ohms in loop mode)

Sensors

Gas type		Measurement range (ppm)	Explosion proof sensor	Intrinsically safe sensor	Temp. range (°C)	% RH	Accuracy (ppm)	Average service life (months)	Resp. time T50/T90 (s)	Storage conditions and time
Combustible gases	Catalytic	0-100% LEL	■		-20 to +55	0-95	+/-1% LEL (from 0-70% LEL)	40	6/15 (CH4)	(b)
AsH ₃	Arsine	1.00		■	-20 to +40	20 - 90	+/- 0.05	18	30/120	(a)
Cl ₂	Chlorine	10.0		■	-20 to +40	10 - 90	+/- 0.4	24	10/60	(a)
ClO ₂	Chlorine dioxide	3.00		■	-20 to +40	10 - 90	+/- 0.3	24	20/120	(a)
CO	Carbon monoxide	100 300 1000	■ ■ ■	■ ■ ■	-20 to +50	15 - 90	+/- 3 (0-100 range)	40	15/40	(a)
CO ₂	Carbon dioxide	0-5% vol.	■		-20 to +55	0 - 95	+/- 3%	48	11/30	(a)
COCl ₂	Phosgene	1.00		■	-20 to +40	15 - 90	+/- 0.05	12	60/180	(c)
ETO	Ethylene oxide	30.0		■	-20 to +50	15 - 90	+/- 1.0	36	50/240	(a)
H ₂	Hydrogen	2000	■	■	-20 to +50	15 - 90	+/- 5%	24	30/50	(a)
H ₂ S	Hydrogen sulfide	30.0 100 1000	■ ■ ■	■ ■ ■	-20 to +50	15 - 90	+/- 1.5 (0-30 range)	36	15/30	(a)
HCl	Hydrogen chloride	30.0 100		■	-20 to +40	15-95	+/- 0.4 (0-30 range)	24	30/150	(a)
HCN	Hydrogen cyanide	30.0		■	-20 to +40	15-95	+/- 0.3 (0-10 range)	18	30/120	(c)
HF	Hydrogen fluoride	10.0		■	-10 to +30	20 - 80	+/- 5%	12	40/90	(c)
NH ₃	Ammonia	100 1000 5000	■ ■ ■	■ ■ ■	-20 to +40	15 - 90	+/- 5 +/- 20 +/- 150 or 10%	24	25/70 20/60 60/180	(a)
NO	Nitric oxide	100 300 1000	■ ■ ■	■ ■ ■	-20 to +50	15 - 90	+/- 2 (0-100 range)	36	10/30	(a)
NO ₂	Nitrogen dioxide	30.0			-20 to +50	15-90	+/-0.8	24	30/60	(a)
O ₂	Oxygen	0-30% vol.	■	■	-20 to +50	15 - 90	0.4% vol. (from 15-22% O ₂)	28	6/15	(a)
O ₃	Ozone	1.00		■	0 to +40	10 - 90	+/- 0.03 (from 0-0.2 ppm) +/- 0.05 (from 0.2-1 ppm)	18	40/120	(c)
PH ₃	Phosphine	1.00		■	-20 to +40	20 - 90	+/- 0.05	18	30/120	(a)
SiH ₄	Silane	50.0		■	-20 to +40	20 - 95	+/- 1.0	18	25/120	(a)
SO ₂	Sulfur dioxide	10.0 30.0 100		■ ■ ■	-20 to +50	15 - 90	+/- 0.7 (0-10 range)	36	15/45	(a)
CH ₂ Cl	Chloro-methane	500	■		-20 to +55	20 - 95	+/- 15% (from 20-70% PE)	40	25/90	(d)
CH ₂ Cl ₂	Dichloro-methane	500	■		-20 to +55	20 - 95	+/- 15% (from 20-70% PE)	40	25/90	(d)
Freon R12		1% vol.	■		-20 to +55	20 - 95	+/- 15% (from 20-70% PE)	40	25/90	(d)
Freon R22		2000	■		-20 to +55	20 - 95	+/- 15% (from 20-70% PE)	40	25/90	(d)
Freon R123		2000	■		-20 to +55	20 - 95	+/- 15% (from 20-70% PE)	40	25/90	(d)
FX56		2000	■		-20 to +55	20 - 95	+/- 15% (from 20-70% PE)	40	25/90	(d)
Freon R134a		2000	■		-20 to +55	20 - 95	+/- 15% (from 20-70% PE)	40	25/90	(d)
Freon R11		1% vol.	■		-20 to +55	20 - 95	+/- 15% (from 20-70% PE)	40	25/90	(d)
Freon R23		1% vol.	■		-20 to +55	20 - 95	+/- 15% (from 20-70% PE)	40	25/90	(d)
Freon R143a		2000	■		-20 to +55	20 - 95	+/- 15% (from 20-70% PE)	40	25/90	(d)
Freon R404a		2000	■		-20 to +55	20 - 95	+/- 15% (from 20-70% PE)	40	25/90	(d)
Freon R507		2000	■		-20 to +55	20 - 95	+/- 15% (from 20-70% PE)	40	25/90	(d)

Gas type		Measurement range (ppm)	Explosion -proof sensor	Intrinsically -safe sensor	Temp. range (°C)	% RH	Accuracy (ppm)	Average service life (months)	Resp. time T50/T90 (s)	Storage conditions and time
Freon R410a		1000	■		-20 to +55	20 - 95	+/- 15% (from 20-70% PE)	40	25/90	(d)
Freon R32		1000	■		-20 to +55	20 - 95	+/- 15% (from 20-70% PE)	40	25/90	(d)
Freon R407c		1000	■		-20 to +55	20 - 95	+/- 15% (from 20-70% PE)	40	25/90	(d)
Freon R408a		1000	■		-20 to +55	20 - 95	+/- 15% (from 20-70% PE)	40	25/90	(d)
Ethanol		500	■		-20 to +55	20 - 95	+/- 15% (from 20-70% PE)	40	25/60	(d)
Toluene		500	■		-20 to +55	20 - 95	+/- 15% (from 20-70% PE)	40	25/60	(d)
Isopropanol		500	■		-20 to +55	20 - 95	+/- 15% (from 20-70% PE)	40	25/60	(d)
2-butanone (MEK)		500	■		-20 to +55	20 - 95	+/- 15% (from 20-70% PE)	40	25/60	(d)
Xylene		500	■		-20 to +55	20 - 95	+/- 15% (from 20-70% PE)	40	25/60	(d)

a) +4°C to +20°C
20% to 60% RH
1 bar ± 10%
6 months maximum

b) -25°C to +60°C
20% to 60% RH
1 bar ± 10%
6 months maximum

(c) +4°C to +20°C
20% to 60% RH
1 bar ± 10%
3 months maximum

(d) -20°C to +50°C
20% to 60% RH
1 bar ± 10%
6 months maximum

Cross gas factors for combustible gases

It is recommended that the detector is calibrated using the gas to be measured. Users wishing to calibrate the detector using a gas other than detected and factory-programmed should refer to the following table, and use the recommended gas and corresponding coefficient.

Poison resistant catalytic sensor, type 4F

Gas	Methane	Pentane	Hydrogen
Acetone	1.80	0.90	
Acetylene	1.40	0.70	
Ammonia	1.00	0.50	
Benzene	2.10	1.05	
n-Butane	1.80	0.90	
Ethane	1.40	0.70	
Ethanol	1.60	0.80	
Ethylene	1.40	0.70	
n-Hexane	2.85	1.40	
Hydrogen			1.00
Isopropanol	1.80	0.90	
JP-4	3.00	1.50	
JP-5	3.10	1.55	
JP-8	3.20	1.60	
Methane	1.00		
Methanol	1.35	0.65	
n-Pentane	2.00	1.00	
Propane	1.60	0.80	
Styrene	2.40	1.20	
Toluene	2.50	1.25	
Xylene	2.40	1.20	

Poison resistant catalytic sensor, type VQ1

Gas	Molecular formula	LEL (% v/v)	UEL (% v/v)	CH4 coef.	H2 coef.	C4H10 coef.	C5H12 coef.
Ethyl acetate	C ₄ H ₈ O ₂	2.10	11.50	1.65		0.90	0.80
Acetone	C ₃ H ₆ O	2.15	13.00	1.65		0.90	0.80
Acetylene	C ₂ H ₂	2.30	100	2.35	1.90	1.25	1.15
Acrylic acid	C ₃ H ₄ O ₂	2.40	8.00	5.00		2.65	2.40
Butyl acrylate	C ₇ H ₁₂ O ₂	1.20	8.00	3.50		1.85	1.70
Ethyl acrylate	C ₅ H ₈ O ₂	1.70	13.00	3.05		1.65	1.50
Acrylonitrile	C ₃ H ₃ N	2.80	28.00	1.45	1.20	0.80	0.70
Ammonia	NH ₃	15.00	30.20	0.90	0.75	0.50	0.45
Benzene	C ₆ H ₆	1.20	8.00	4.00		2.15	1.90
1,3-butadiene	C ₄ H ₆	1.40	16.30	2.55		1.35	1.25
Butane	C ₄ H ₁₀	1.50	8.50	1.90		1.00	0.90
Butanol (butyl alcohol)	C ₄ H ₁₀ O	1.4	11.3	1.95		1.05	0.95
2-butanone (MEK)	C ₄ H ₈ O	1.80	11.50	3.90		2.10	1.90
Cyclohexane	C ₆ H ₁₂	1.20	8.30	2.00		1.10	1.00
Dimethylether	C ₂ H ₆ O	3.00	27.00	1.80		0.95	0.90
Dodecane	C ₁₂ H ₂₆	0.60	~6.0	4.00		2.15	1.90
Ethane	C ₂ H ₆	3.00	15.50	1.50		0.80	0.75
Ethanol	C ₂ H ₆ O	3.30	19.00	2.15	1.75	1.15	1.05
Ether (diethylether)	(C ₂ H ₅) ₂ O	1.70	36.00	1.90		1.00	0.90
Ethylene	C ₂ H ₄	2.70	34.00	1.65	1.35	0.90	0.80
G.P.L. ²	Prop+But	1.65	~9.0	1.9		1.00	0.90
Diesel	mixture	0.60	~6.0	3.20		1.70	1.55
Natural gas	CH ₄	5.00	15.00	1.05		0.60	0.50
Heptane ⁴	C ₇ H ₁₆	1.10	6.70%	2.20		1.20	1.05
Hexane ⁴	C ₆ H ₁₄	1.20	7.40	2.10		1.15	1.00
Hydrogen	H ₂	4.00	75.60		1.00		
Isobutane	C ₄ H ₁₀	1.50	8.40	1.50		0.80	0.75
Isobutylene	C ₄ H ₈	1.60	10.00	2.20		1.20	1.05
Isopropanol	C ₃ H ₈ O	2.15	13.50	1.60		0.85	0.80
Kerosene (JP-4)	C ₁₀ -C ₁₆	0.70	5.00	5.00		2.65	2.40
Methyl methacrylate	C ₅ H ₈ O ₂	2.10	12.50	2.25		1.20	1.10
Methane	CH ₄	5.00	15.00	1.00			
Methanol (methyl alcohol)	CH ₃ OH	5.50	44.00	1.40	1.15	0.75	0.70
Naphtha	mixture	0.90	5.90%	3.50		1.85	1.70
Nonane	C ₉ H ₂₀	0.70	5.60	4.40		2.35	2.10
Octane	C ₈ H ₁₈	1.00	6.00	2.70		1.45	1.30
Ethylene oxide (epoxyethane)	C ₂ H ₄ O	2.60	100	2.10	1.70	1.15	1.00
Propylene oxide (epoxypropane)	C ₃ H ₆ O	1.90	37.00	2.35	1.90	1.25	1.15
Pentane	C ₅ H ₁₂	1.40	8.00	2.10		1.15	1.00
Propane	C ₃ H ₈	2.00	9.5	1.55		0.85	0.75
Propylene	C ₃ H ₆	2.00	11.70	1.65		0.90	0.80

Gas	Molecular formula	LEL (% v/v)	UEL (% v/v)	CH4 coef.	H2 coef.	C4H10 coef.	C5H12 coef.
Styrene (vinyl benzene)	C ₈ H ₈	1.1	8.00	6.30		3.35	3.00
Premium unleaded gasoline (95)	-	1.10	~6.0	1.80		0.95	0.90
Toluene	C ₇ H ₈	1.20	7	4.00		2.15	1.90
Turpentine oil	-	0.8	6.0	3.50		1.85	1.70
Triethylamine	C ₆ H ₁₅ N	1.20	8	2.05		1.10	1.00
White spirit	mixture	1.10	6.50	3.50		1.85	1.70
Xylene	C ₈ H ₁₀	1.00	7.60	4.00		2.15	1.90

Items in gray: recommended gas for calibrating the detector.

Example

Calibration of an “acetone” detector using a calibration gas with 1% butane

Value to be displayed:

$$\frac{1\% \text{ (injected butane)}}{1.5\% \text{ (butane LEL)}} \times 100 \times 0.90 \text{ (butane/acetone coefficient)} = 60\% \text{ LEL}$$

Note:

- LELs vary according to the source.
- Coefficients are accurate to ± 15%.



DECLARATION UE DE CONFORMITE EU Declaration of Conformity



La société **Oldham S.A.S.**, ZI Est 62000 Arras France, atteste que les
Oldham S.A.S. Company, ZI Est 62000 Arras France, declares that

Détecteurs de gaz OLC 20 et OLCT 20 **Gas detectors OLC 20 and OLCT 20**

sont conformes aux exigences des Directives Européennes suivantes:
comply with the requirements of the following European Directives:

D) Directive Européenne ATEX 2014/34/UE du 26/02/14 : Atmosphères Explosives *European Directive ATEX 2014/34/UE dated from 26/02/14: Explosive Atmospheres*

Normes harmonisées appliquées (règles de construction) **EN 60079-0:2012/A11 :2013, EN 60079-1:2014, EN 60079-11:2012, EN 60079-26:2015, EN 60079-31:2014**
Harmonised applied Standards (rules of construction)

Normes appliquées (métrologie) **EN 50104:2002** Exigences d'aptitude à la fonction des détecteurs d'oxygène
Applied standards (metrology) **EN 50054:1998** *(Performance requirements of detectors for oxygen)*
EN 50057:1998 Exigences d'aptitude à la fonction des détecteurs de gaz
(Performance requirements of detectors for flammable gases) - Méthane (Methane) - capteur (sensor) standard C1000-VQ1

Marquage (marking)

OLC20d ou (or) OLCT20d

II 2 G D
Ex db IIC T6 Gb
Ex tb IIIC T85°C Db
T. Amb: -20°C to 70°C

OLC20d HT

II 2 G D
Ex db IIC T* Gb
Ex tb IIIC T* Db
(* T4 for T_{amb} up to 110°C, T3 for T_{amb} up to 180°C, T2 for T_{amb} up to 200°C

OLCT20i

II 1 G D I M1
Ex ia IIC T4 Ga *EX ia I Ma*
Ex ia IIIC T135°C Da *T. Amb: -20°C to 70°C*
T. Amb: -20°C to 70°C

Attestation UE de Type du matériel
EU type examination certificate

INERIS 01ATEX0004X

Délivré par l'Organisme Notifié numéro 0080
Issue by Notified Body No. 0080

INERIS, Parc Alata
60550 Verneuil-en-Halatte, France

Notification Assurance Qualité de Production
Notification of the Production QA

INERIS 00 ATEX Q403

Délivré par l'Organisme Notifié numéro 0080
Issue by Notified Body No. 0080

INERIS, Parc Alata
60550 Verneuil-en-Halatte, France

Note : les OLC 20 et OLCT 20 sont compatibles avec les centrales de détection (are compatible with gas controllers) MX 15, MX 32, MX 42A, MX 43, MX 48, MX 52, MX 62 and WINGAS.



II) Directive Européenne CEM 2014/30/UE du 26/02/14: Compatibilité Electromagnétique
The European Directive EMC 2014/30/UE dated from 26/02/2014: Electromagnetic compatibility

Normes harmonisées appliquées **EN 50270:2015** (type 2) CEM – Appareils de détection de gaz
(Harmonised applied Standards) EMC – Apparatus for the detection of gases

Sécurité de fonctionnement (Functional Safety)

Normes appliquées **EN 50402**
Applied Standards

L'analyse de fiabilité, objet du rapport INERIS n° CGR 74448 du 06 juillet 2006 a permis de déterminer le taux de défaillances dangereuses non détectées pour les OLC 20 et OLCT 20 pour gaz combustibles (hors version HT) :
The reliability analysis, based on INERIS report n° CGR 74448 of 06 July 2006 has determined that the dangerous failure rate for OLC 20 and OLCT 20 (except HT versions) for combustible gases is:

$$\lambda_{da} = 4.42 \cdot 10^{-2} \text{ par an (per year)}$$

Les détecteurs de gaz explosibles et d'oxygène type OLC 20 et OLCT 20 ont un niveau :
OLC 20 and OLCT 20 combustible and oxygen gas detectors are:

SIL 2 avec un intervalle de maintenance (Ti) de 3 mois au plus, **PFD_{avg} = 0,55.10⁻²**
SIL 2 compliant with a maintenance interval no greater than 3 months

SIL 1 avec un intervalle de maintenance (Ti) de 6 mois au plus, **PFD_{avg} = 1,1.10⁻²**
SIL 1 compliant with a maintenance interval no greater than 6 months

Note: Les taux de défaillances calculés ne sont valables que durant la durée de vie réelle des éléments sensibles (intervalle de temps limité, de l'ordre de 3 à 5 ans). Au-delà, de par le vieillissement des cellules de mesure, le taux n'est plus significatif. La norme EN50402 assume pour les modules simples comme les capteurs OLC 20 et OLCT20, une proportion effective de défaillance en sécurité (SFF) comprise entre 60 % et 90 %.

Note: The calculated failure rates are only valid on the real lifetime of the sensitive elements (limited time, about 3 to 5 years). Beyond that, due to ageing of the measuring cells, the rate is not significant any more. The EN50402 standard assumes for the simple modules like OLC 20 and OLCT20 detectors, an effective Safety Failure Fraction (SFF) between 60% and 90%.

Page 2 sur 2 (page 2 out of 2)

Arras, le 11/04/18 (April 11th, 2018)

Oldham S.A.S.
Z.I. EST – CS 20417
62027 ARRAS Cedex – FRANCE



Michel Spellemaeker
Product Manager

UE_ATEX_OLC(T)20_revB

Chapter 10 | Special instructions for use in explosive atmospheres and functional safety

General comments

OLCT 20 gas detectors comply with the requirements of ATEX 2014/34/UE European Directive relating to explosive Dust and Gas atmospheres.

The information given in the following sections should be respected and taken into account by the manager of the site where the equipment is installed. With respect to requirements for improving the safety and health protection of workers potentially at risk from explosive atmospheres, please refer to ATEX 1999/92/CE European Directive.

Warnings

Do not open when energized. After de-energizing, delay 2 minutes before opening. Read instructions notice (cable glands).

Requirements for use in dust explosive atmospheres

For the equipment installed in dust explosive atmosphere, user shall ensure a sufficient cleaning to prevent dust accumulation on the device. The maximum permissible thickness of a dust layer must be less than 5 mm.

Cable entries

Cable glands and other wiring accessories (plugs, adaptors, etc.) shall be “db” certified for use in gas explosive atmospheres and “tb” for use in dust explosive atmospheres. They must be at least IP66 and of M20x1.5 6g or M25x1.5 6g types in accordance with ISO965-1 and ISO965-3 standards. Minimum depth of engagement must be 5 threads and installation must be done in accordance with current version of EN 60079-14 and eventually with any local or national additional requirements that may apply in the country of installation.

The cables should be suitable for use at a temperature equal to or greater than 80°C.

Threaded joints

Threaded joints have different values than those specified in EN60079-1 standard. Oldham does not allow the repair of the threaded joints and shall not be held responsible for any damage to the equipment or for any physical injury or death resulting from any product modification.

The threaded joints on the *OLCT 20* may be lubricated to ensure protection against explosions. Only non-hardening lubricants or non-corrosive agents without volatile solvents may be used. Warning: silicone-based lubricants are strictly prohibited since they contaminate some of the gas sensing elements used in the *OLCT 20*.

Limitations of use

Gas detection cells have certain limitations that shall be known and understood by the user.

Overrange and exposition to specific components

- A bump test and/or a calibration is recommended each time the detector has been exposed to high gas concentration and moreover if the detector went to overrange condition.
- Vapors from silicone or sulfur compounds can affect the catalytic sensor and thereby distort the measurements. If the sensors have been exposed to these types of compounds, an inspection or calibration must be performed.
- High concentration of organic solvents (e.g. alcohols, aromatic solvents, etc.) or exposure to gas concentration above the measuring range can damage electrochemical sensors. If sensors have been exposed to such condition, a bump test or calibration must be then performed.
- In the event of high levels of Carbon Dioxide ($\text{CO}_2 > 1\% \text{ vol.}$), electrochemical Oxygen (O_2) sensors can slightly overestimate the actual concentration of oxygen by 0.1 to 0.5% volume.

Operation under low oxygen levels

- If an electrochemical detector sensor is used in an atmosphere comprising less than 1% oxygen for over one hour, the measurement may be an underestimate.
- If a thermocatalytic detector sensor is used in an atmosphere comprising less than 10% oxygen, the measurement may be an underestimate.
- If a semiconductor detector sensor is used in an atmosphere comprising less than 18% oxygen, the measurement may be an underestimate.

Installation and calibration

- The detector will be installed with the sensor cell pointing downwards
- The detector should be calibrated with the gas to be measured. With respect to combustible gases only, and in the event it is impossible to calibrate with the targeted gas, see tables on pages 21 and further for recommended calibration gas and cross gas interference.

Transfer curve for OLCT20 gas detectors

The curve below gives the transmitter output current as a function of gas concentration. In the event that the user connects the transmitter to a non-Oldham central controller, the user must ensure that the transfer curve is compatible with the equipment's input characteristics to correctly interpret the data coming in from the transmitter. Similarly, the central controller must provide sufficient voltage to compensate for any voltage drop caused by the cable.

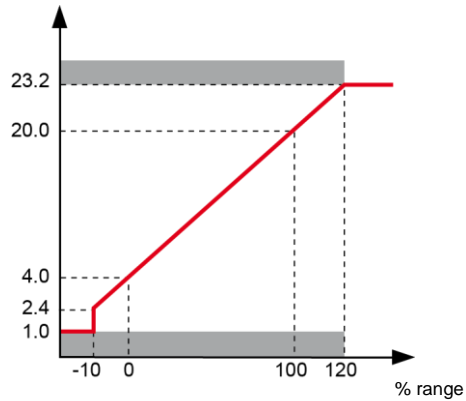

Marking

Safety relevant parameters:

OLC 20d and OLC 20d HT

- Maximum supply voltage: 2,8 Vdc
- Maximum supply current: 400 mA
- Maximum power: 0,8 W

OLCT 20d

- Maximum input voltage: 30 Vdc
- Maximum input current: 100 mA

OLCT 20i

U _i (V)	I _i (mA)	P _i (mW)	C _i (nF)	L _i (μH)
28	94	658	46	15

OLC 20d detector

OLDHAM SAS
62027, ARRAS France
OLC20d
CE0080
INERIS 01ATEX0004X



II 2 G D
Ex db IIC T6 Gb
Ex tb IIIC T85°C Db
T.Amb : -20°C to 70°C

WARNING: Do not open when energized. Read user manual (cable entry).

OLC 20d HT detector

OLDHAM SAS
62027, ARRAS France

OLC20d HT
CE0080

INERIS 01ATEX0004X

 II 2 G D

Ex db IIC T* Gb

Ex tb IIIC T* Db

T.Amb : -20 °C to T* °C

(*) T4 for T_{amb} up to +110 °C, T3 for T_{amb} up to +180 °C, T2 for T_{amb} up to 200 °C

WARNING: Do not open when energized. Read user manual (cable glands).

OLCT 20d detector

OLDHAM SAS
62027, ARRAS France

OLCT20d
CE0080

INERIS 01ATEX0004X

 II 2 G D

Ex db IIC T6 Gb

Ex tb IIIC T85 °C Db

T.Amb : -20 °C to 70 °C

WARNING: Do not open when energized. Read user manual (cable entry).

OLCT 20i detector

OLDHAM SAS
62027, ARRAS France

OLCT20i
CE0080

INERIS 01ATEX0004X

 II 1 G D

Ex ia IIC T4 Ga

Ex ia IIIC T135 °C Da

T.Amb : -20 °C to 70 °C

WARNING: Read user manual (cable entry).

OLCT 20i detector (for mine)

OLDHAM SAS

62027, ARRAS France

OLCT20i

CE0080

INERIS 01ATEX0004X

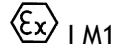

Ex ia I Ma

T.Amb : -20°C to 70°C

WARNING: Read user manual (cable entry).



EUROPEAN PLANT AND OFFICES

Z.I. Est – rue Orfila CS 20417 – 62027 Arras Cedex FRANCE
Tél: +33 (0)3 21 60 80 80 – Fax: +33 (0)3 21 60 80 00
Website: <https://gasdetection.3m.com>

AMERICAS
Tel: +1-713-559-9280
Fax: +1-281-292-2860

ASIA PACIFIC
Tel: +86-21-3127-6373
Fax: +86-21-3127-6365

EUROPE
Tel: +33-321-608-080
Fax: +33-321-608-000

contact info : gasandflamedetection@mmm.com